

Bar Linear Hidden Flange Register

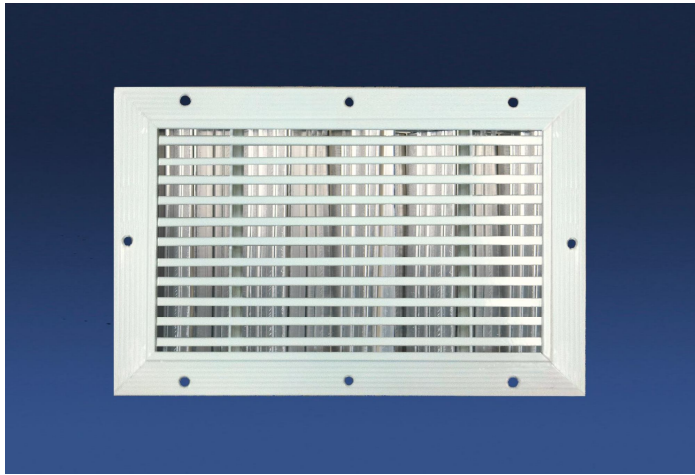

Not suitable for floor use

DABLDH

- Fully extruded aluminum construction for a stylish built-in look
- Hidden flange frame designed to be installed underneath drywall
- Fixed blades designed for long straight air throw
- Opposed Blade Damper with slide operator attached to the back
- Sections longer than 84" are joined together for continuous appearance with the aligning pins provided
- Available on 1/2" increments as standard
- Custom sizes available, but extra charge may apply
- Durable powder coat painted finish
- Available in White, Silver, Brown, Mill or Special*
- Plaster finishing is the responsibility of the installer

HOW TO ORDER
DABLDH - 00 - TB 30 x 4 COLOR

Blade	Mounting	Length & Height	White, Silver
-00,-01,-15	A or TB		Brown, Mill
-30,-82,-84			or Special*

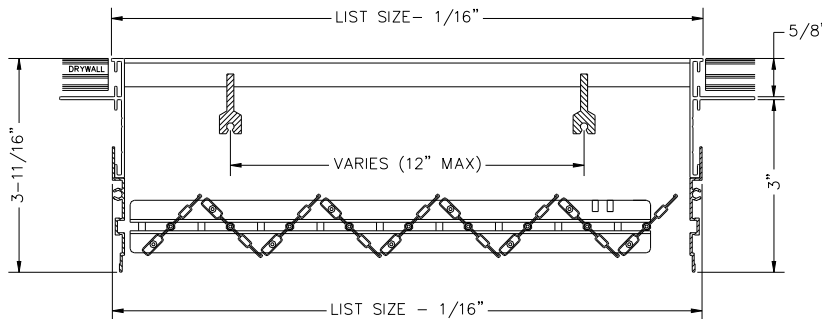
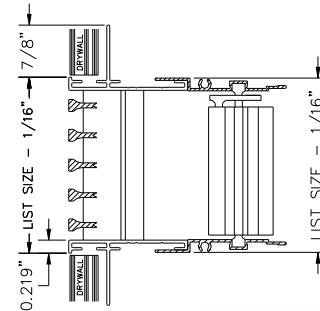
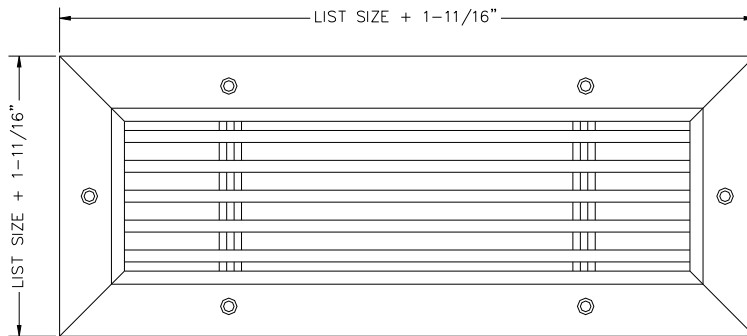

NEW

• New Hidden flange frame design for a built-in look

MUST BE PRE-INSTALLED BEFORE DRYWALL



MODEL	DABLDH
FACE BLADES	Horizontal Fixed
REAR BLADES	n/a
DAMPER	n/a
MATERIAL	Aluminum
COLOR	White/Silver/Mill Brown/Special*

JOB NAME: _____

LOCATION: _____

ARCHITECT: _____

ENGINEER: _____

CONTRACTOR: _____



Bar Linear Blade Options

-00-

0° 13/64" blades on 1/2" centers

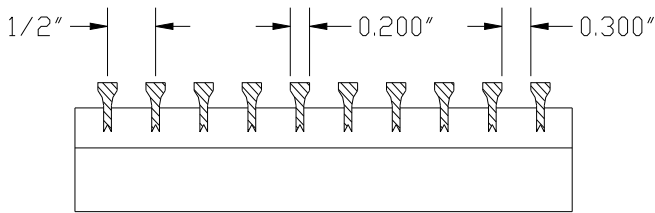

-01-

0° 1/4" blades on 1/2" centers

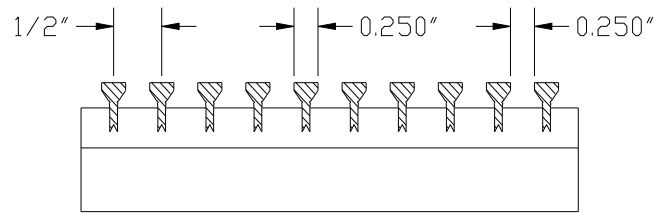

-15-

15° 13/64" blades on 1/2" centers

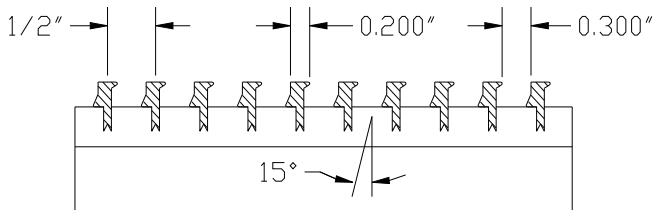

-30-

30° 13/64" blades on 1/2" centers

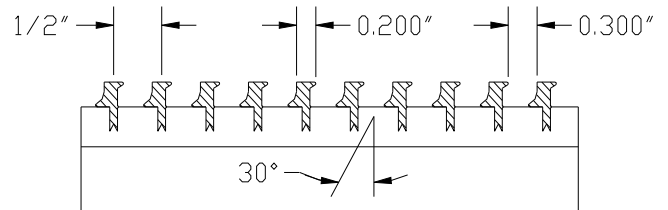

-82-

0° 1/8" blades on 1/2" centers

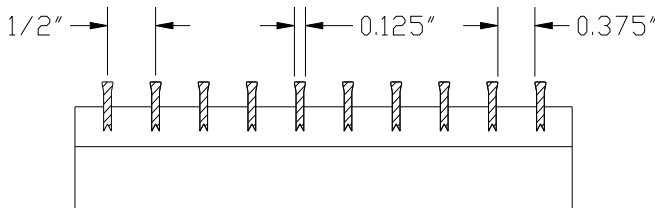

-84-

0° 1/8" blades on 1/4" centers

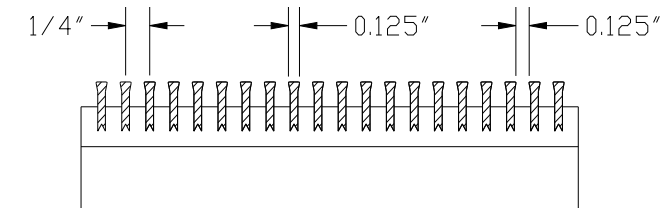

- Additional charges apply for the -84 core option

Bar Linear Mounting Options

-A
SCREWS

Color matched screws with countersunk screw holes.
Suitable for ceiling, wall or sill installation.

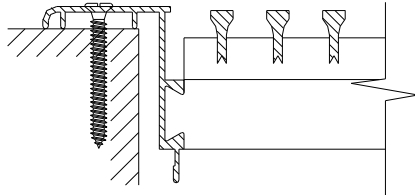

-B
SPRING CLIPS

Clips behind the flange keep grille snug in opening and are not visible from the face.
Only for floor and sill applications.
NOT suitable for wall or ceiling use.

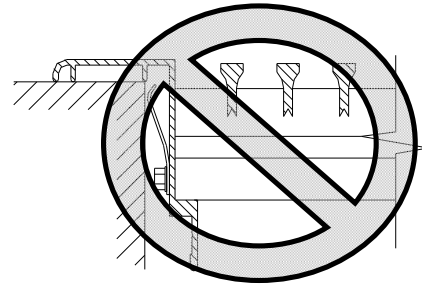

-C
CONCEALED BRACKETS

Grille gets fastened to duct-mounted brackets that are concealed behind the blades.
Suitable for ceiling, wall or sill installation.

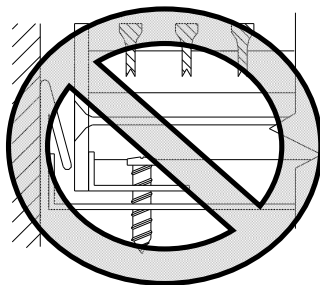

These mounting options are not available with the hidden frame

-D
SIDEWALL SCREW HOLES

Screw holes drilled at 45° on inner flange.
Only available with **-R Removable core.**
(Removable option not available for floor)
Suitable for ceiling, wall or sill installation.

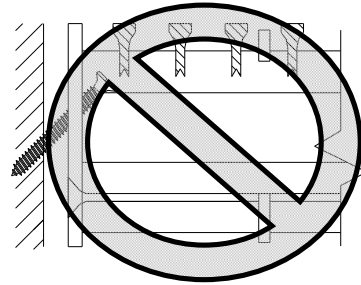

-TB
NO MOUNTING OPTION

For custom applications.

