

Bar Linear No Flange Removable Core Register



DABLDRN

- Fully extruded aluminum construction
- No flange frame designed for a stylish built-in look
- Removable core held in place with clips
- Fixed blades designed for long straight air throw
- Opposed Blade Damper with slide operator attached to the back
- Sections longer than 84" are joined together for continuous appearance with the aligning pins provided
- Available on 1/2" increments as standard
- Custom sizes available, but extra charge may apply
- Durable powder coat painted finish
- Available in White, Silver, Brown, Mill or Special*
- Plaster finishing is the responsibility of the installer

Not suitable for floor use

HOW TO ORDER
DABLDRN - 00 - TB 30 x 4 COLOR

Blade	Mounting	Length & Height	White, Silver
-00, -01, -15	C, D or TB		Brown, Mill or Special*
-30, -82, -84			

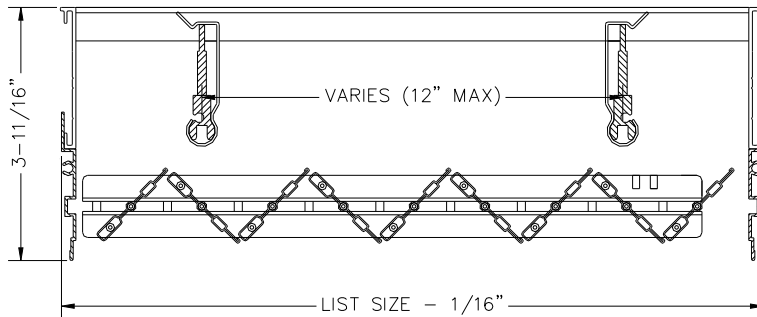
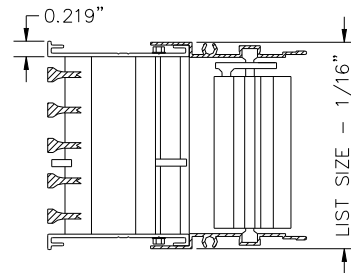
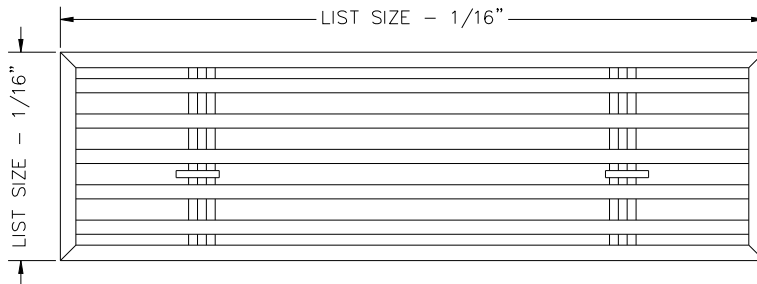

• Improved frame design for a better fit
 • Now List Size - 1/16"



MODEL	DABLDRN
FACE BLADES	Horizontal Fixed
REAR BLADES	n/a
DAMPER	Opposed Blade
MATERIAL	Aluminum
COLOR	White/Silver/Mill Brown/Special*

JOB NAME: _____

LOCATION: _____

ARCHITECT: _____

ENGINEER: _____

CONTRACTOR: _____

Bar Linear Blade Options

-00-

0° 13/64" blades on 1/2" centers

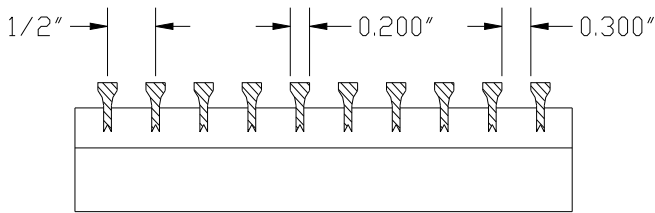

-01-

0° 1/4" blades on 1/2" centers

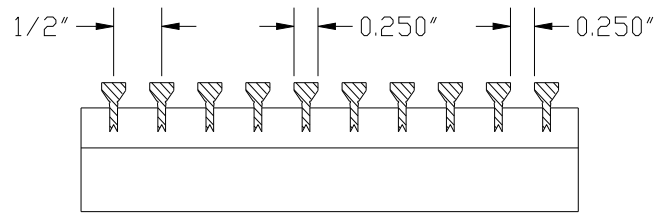

-15-

15° 13/64" blades on 1/2" centers

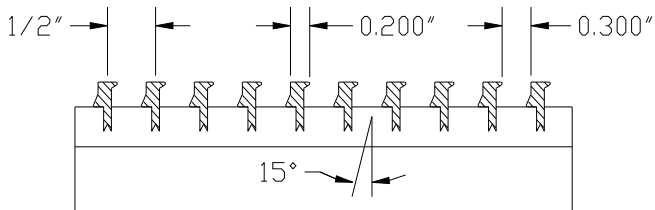

-30-

30° 13/64" blades on 1/2" centers

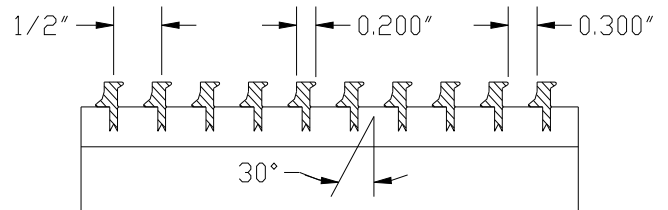

-82-

0° 1/8" blades on 1/2" centers

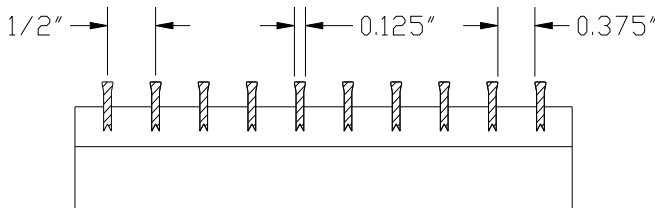

-84-

0° 1/8" blades on 1/4" centers

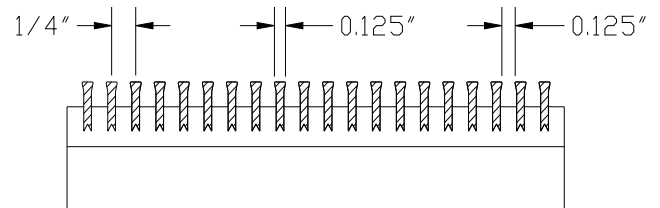

- Additional charges apply for the -84 core option

Bar Linear Mounting Options

-A
SCREWS

Color matched screws with countersunk screw holes.
Suitable for ceiling, wall, sill or floor installation.

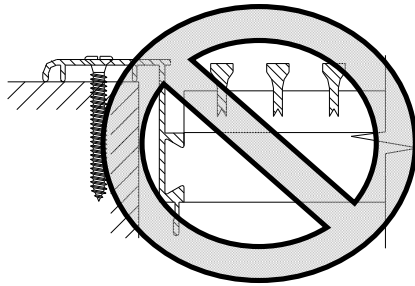

-B
SPRING CLIPS

Clips behind the flange keep grille snug in opening and are not visible from the face.
Only for floor and sill applications.
NOT suitable for wall or ceiling use.

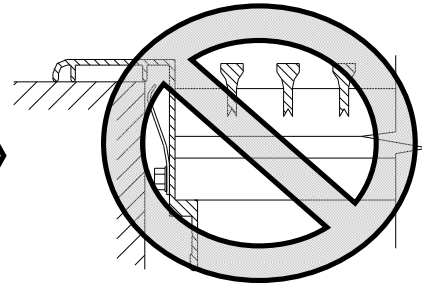

These mounting options
are only available with
flanged grilles

-C
CONCEALED BRACKETS

Grille gets fastened to duct-mounted brackets that are concealed behind the blades.
Suitable for ceiling, wall or sill installation.

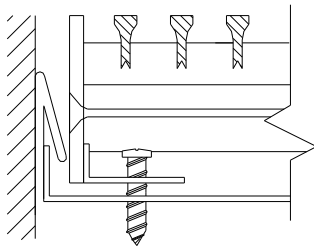

-D
SIDEWALL SCREW HOLES

Screw holes drilled at 45° on inner flange.
Only available with **-R Removable core.**
(Removable option not available for floor)
Suitable for ceiling, wall or sill installation.

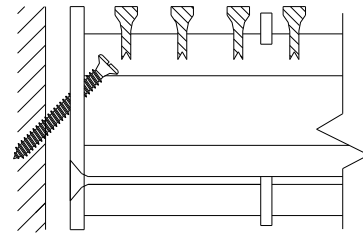

-TB
NO MOUNTING OPTION

Suitable for T-Bar lay-in ceiling & custom applications.
Please allow some clearance for installation.

