

Bar Linear Removable Core Grilles

DABLR



Not suitable for floor use

- Removable core held in place with clips
- Fully extruded aluminum construction for a stylish appearance
- Fixed blades designed for long straight air throw
- Sections joined together for continuous appearance. When longer than 84", aligning pins are provided.
- End caps are included. Open ends can be specified when required.
- Available on 1/2" increments as standard
- Custom sizes available but extra charge may apply
- Durable powdercoat painted finish

HOW TO ORDER

DABLR - 00 - D 30 x 4 COLOR

Grid core	-G	Blade	-00,-01	Width & Height	White
No flange	-N		-15,-30 -82,-84	Mounting A,B,C or D	Silver
					Mill or Brown

Do not leave space if option is not required

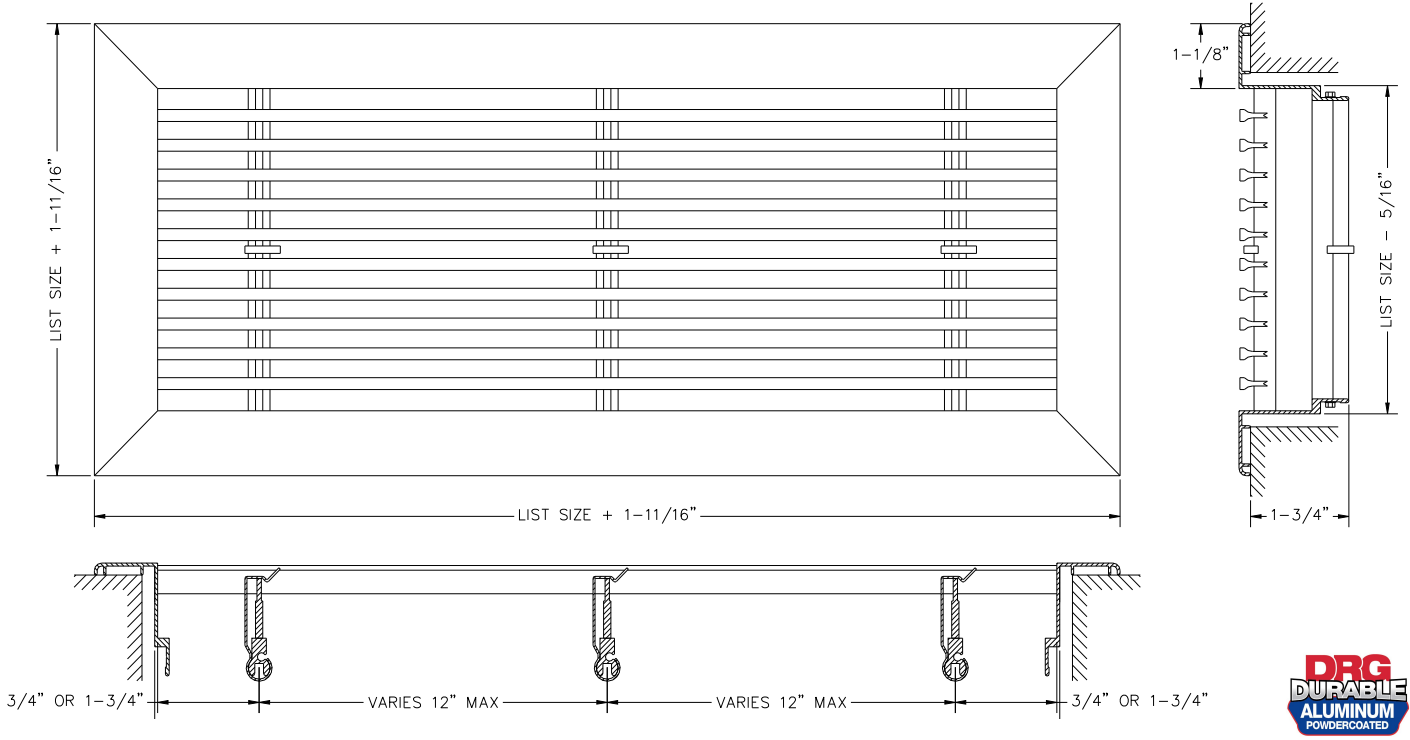

DESCRIPTION	DABLR
FACE BLADES	Horizontal Fixed
REAR BLADES	n/a
DAMPER	n/a
MATERIAL	Aluminum
COLOR	White/Silver/Brown/Mill

JOB NAME: _____

LOCATION: _____

ARCHITECT: _____

ENGINEER: _____

CONTRACTOR: _____

Bar Linear Blade Options

-00-

0° ¹³/₆₄" blades on ½" centers

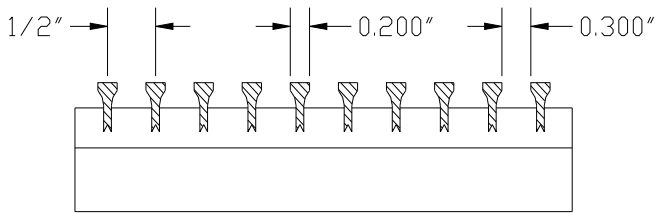

-01-

0° ¹/₄" blades on ½" centers

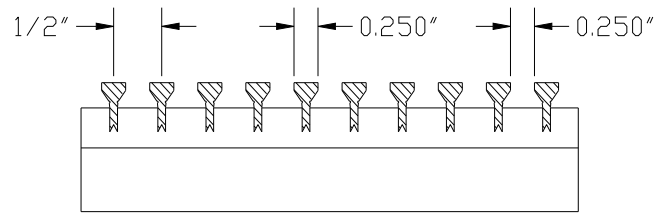

-15-

15° ¹³/₆₄" blades on ½" centers

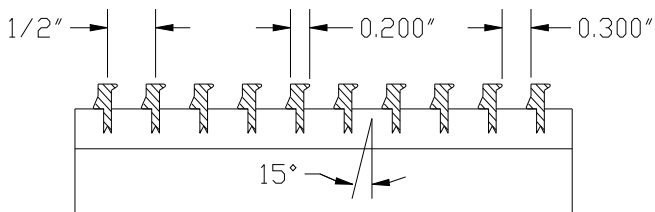

-30-

30° ¹³/₆₄" blades on ½" centers

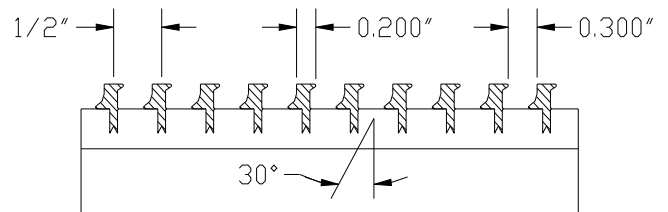

-82-

0° ¹/₈" blades on ½" centers

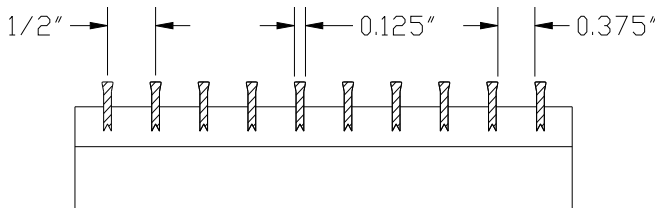

-84-

0° ¹/₈" blades on ¼" centers

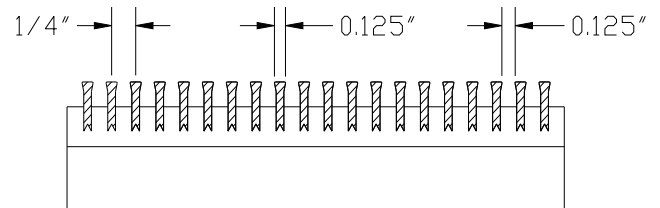

- Additional charges apply for the -84 core option

Bar Linear Mounting Options

**-A
SCREWS**

Color matched screws with counter-sunk screwholes.
Suitable for ceiling, wall, sill or floor installation.

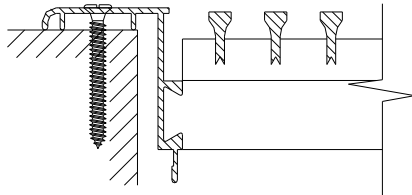

**-B
SPRING CLIPS**

Clips behind the flange keep grille snug in opening and are not visible from the face.
Only for floor and sill applications.
NOT suitable for wall or ceiling use.

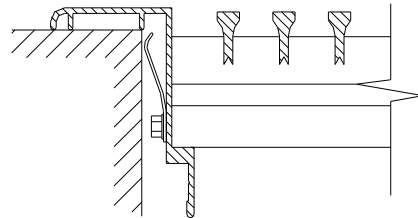

**-C
CONCEALED BRACKETS**

Grille gets fastened to duct-mounted brackets that are concealed behind the blades.
Suitable for ceiling, wall, sill or floor installation.

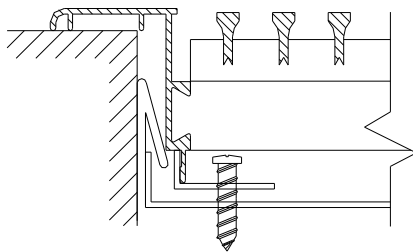

**-D
SIDEWALL SCREWHOLES**

Screw holes drilled at 45° on inner flange.
Only available with **-R Removable core.**
(Removable option not available for floor)
Suitable for ceiling, wall or sill installation.

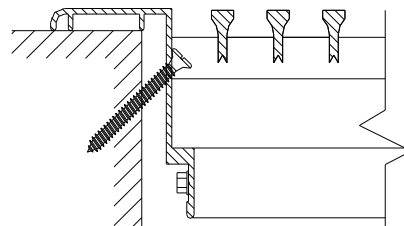

**-TB
NO MOUNTING OPTION**

Suitable for T-Bar lay-in ceiling & custom applications.
Account for the flange by ordering 2" under the T-Bar size.
i.e.: a 22" x 10" grille will have a 23-11/16" x 11-11/16" OD
and will fit a standard 2 ft x 1ft T-Bar opening

