

Extruded Return Air Register

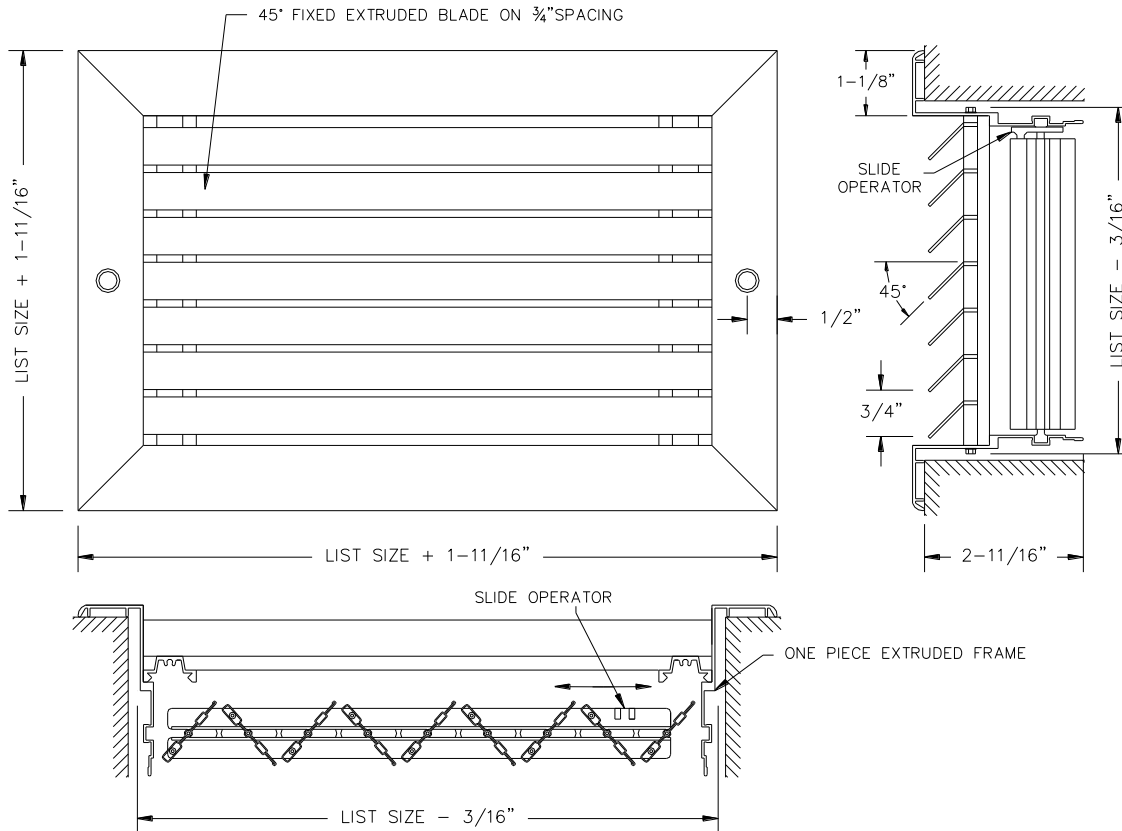

DARHED-45

- Horizontal blades fixed on 45° deflection and 3/4" spacing
- Opposed blade damper with slide operator
- Extruded aluminum blades designed for high efficiency
- Aluminum extruded supports hidden behind for a continuous clean appearance; No face mullions
- Aluminum extruded frame with mechanically locked corners
- Countersunk screw holes c/w painted mounting screws
- Available on 2" increments as standard, minimum size 4"
- Maximum length 78", maximum height is 60"
- Custom sizes available, but extra charge may apply
- Durable powder coat painted finish
- Available in White, Silver, Brown, Mill or Special*



MODEL	DARHED-45
FACE BLADES	45° Fixed Extruded
REAR BLADES	n/a
DAMPER	Opposed Blade
MATERIAL	Aluminum
COLOR	White/Silver/Mill Brown/Special*

JOB NAME: _____

LOCATION: _____

ARCHITECT: _____

ENGINEER: _____

CONTRACTOR: _____